

4603 PAPER HOLDER TYPE 3

4600 Series Premium Collection

Wall Fixings Supplied:
Masonry



Code: 4603POLS

Finish: Polished

GRADE 304 Stainless Steel



Code: 4603BRSH

Finish: Brushed

GRADE 304 Stainless Steel

Dimensions given are in **mm** and [**inches**].
Bathroom Butler® reserves the right to alter and/or remove designs from time to time without prior notice.
This drawing is to be used for reference purposes only. E &O.E.

Copyright Bathroom Butler® 2019

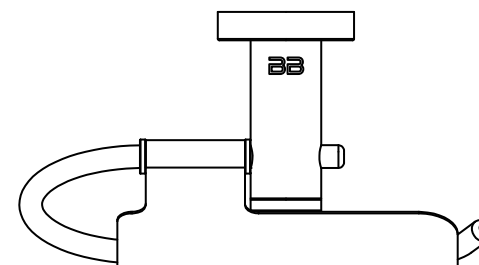

Original UX Fischer® supplied,
phased in from June 2015.

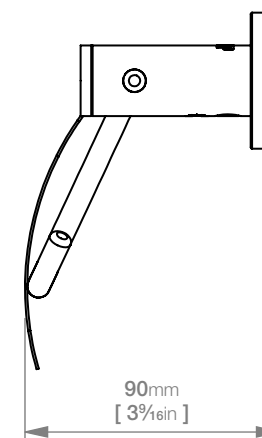
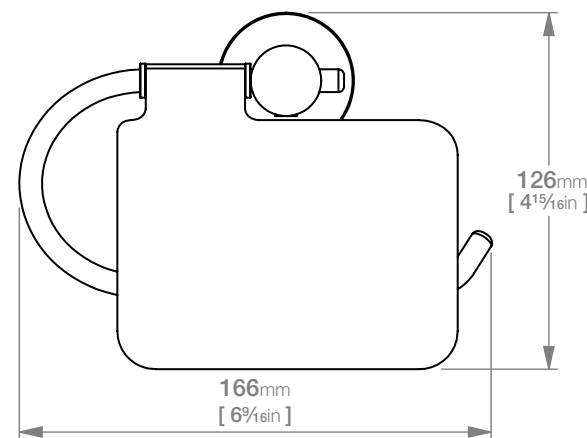
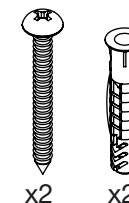

BB™ BATHROOM BUTLER



USA: 631.464.2851 • info@bathroombutler.com • www.bathroombutler.com
South Africa: 0860 104 653 • info@bathroombutler.co.za • www.bathroombutler.co.za
Australia: 1300 133 320 • sales@bathe.net.au • www.bathe.net.au
Mauritius: 230 242 1248 • sales@lisingroup.com • www.bathroombutler.com

Document version **2.3**
Product version **2.1**