

NATURAL 7 Bar 500mm STR-PTS 230V

POLISHED GRADE 304 Stainless Steel

Controller Features - PTSelect Switch:

- Temperature Adjustment • ON / OFF Switch • RED LED Indicator



Controller Technical Specifications:

Controller: PTSelect Switch
INPUT Voltage Range: 190VAC~250VAC
Operating Frequency: 50 Hz $\pm 2\%$
Load Capability: 0.18A~4A
Load Control Range: 40~100%
Standby Current: 3.0mA

HTR Technical Specifications:

Model: NAT07221-PTS-POLS
Size: 524mm (width) x 585mm (height)
Power: 60 Watts
Current: 0.26 Amps
Volts: 230 VAC
IP Rating: IPX5

Suggested Height of Electrical Outlet = 1075mm
(this is only an indication as every installation is different)

NOTES:

- *EO Denotes DUAL ENTRY Electrical Outlet connection
- *PTS Denotes location of PTSelect Switch

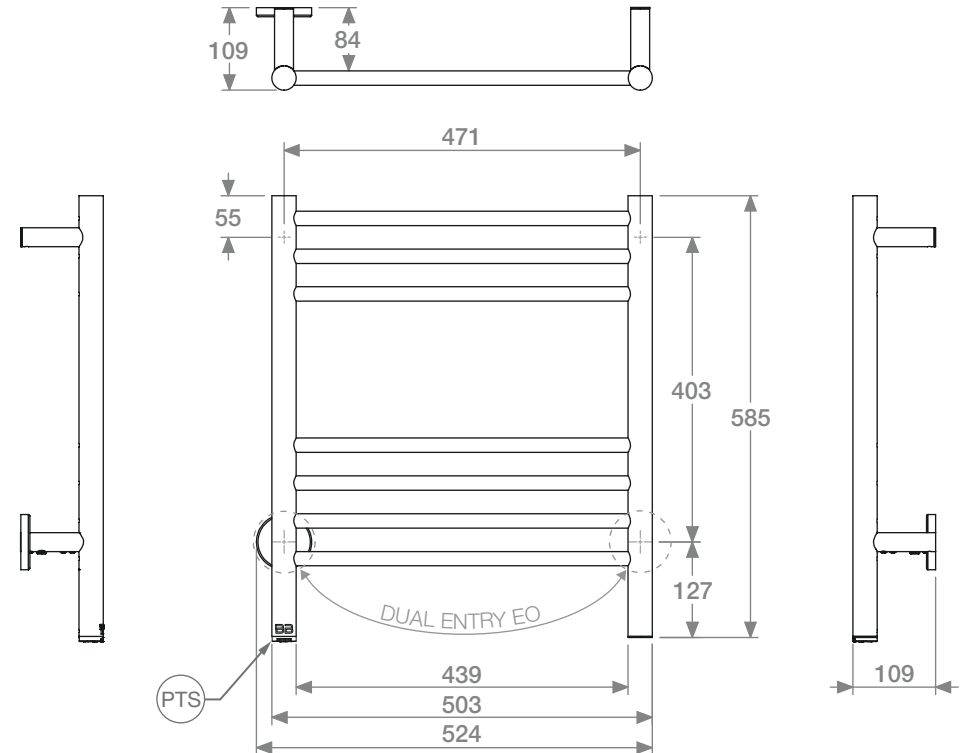

Dimensions given are in mm. Bathroom Butler® reserves the right to alter and/or remove designs from time to time without prior notice. This drawing is to be used for reference purposes only. E & O.E. This product may not be available in your specific country, please check local website for availability.
 Copyright Bathroom Butler® 2016

BB™ BATHROOM BUTLER



South Africa: 0860 104 653 • info@bathroombutler.co.za • www.bathroombutler.co.za
 Australia: 1300 133 320 • sales@bathe.net.au • www.bathe.net.au
 Mauritius: 230 242 1248 • sales@lisinggroup.com • www.bathroombutler.com

Document version **3.3**
 Product version **3.0**